

RECOMMENDED P.C.BOARD HOLE DIMM.

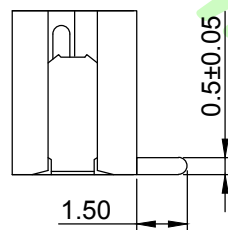
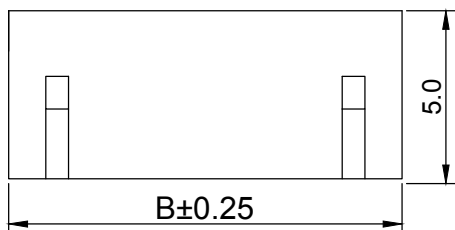

SPECIFICATIONS

Current rating : 1A AC,DC

Voltage rating : 100V AC,DC

Temperature range : -25°C to +85 °C

Contact resistance : 20mΩ Max.

Insulation resistance : 500MΩ Min.

Withstanding voltage : 500V AC/minute

Material : Pin-Brass/Tin-plated

Base-Nylon 9T, UL94V-0

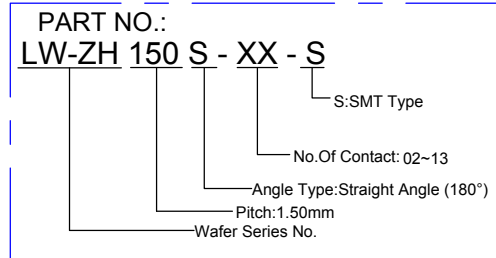

Ordering Information & Dimensions

Poles	Dimension (mm)			Part No.
	A	B	C	
2	1.50	6.00	3.60	LW-ZH150S-02-S
3	3.00	7.50	5.10	LW-ZH150S-03-S
4	4.50	9.00	6.60	LW-ZH150S-04-S
5	6.00	10.50	8.10	LW-ZH150S-05-S
6	7.50	12.00	9.60	LW-ZH150S-06-S
7	9.00	13.50	11.10	LW-ZH150S-07-S
8	10.50	15.00	12.60	LW-ZH150S-08-S
9	12.00	16.50	14.10	LW-ZH150S-09-S
10	13.50	18.00	15.60	LW-ZH150S-10-S
11	15.00	19.50	17.10	LW-ZH150S-11-S
12	16.50	21.00	18.60	LW-ZH150S-12-S
13	18.00	22.50	20.10	LW-ZH150S-13-S

		公差/UNLESS OTHERWISE SPECIFIED TOLERANCES ARE		單位/Unit mm	品名(Title):		鍊亨電子有限公司 LAI HENG TECHNOLOGY LTD. TEL: (02) 8228-6487 FAX: (02) 8228-6486
		X.XX ±0.2 X.X ±0.3		比例/Scale Free	1.50mm Wire-to-Board Header SMT 180° TYPE		
A0	NEW DRAWING	2018.08.16		Size A4	料號/Part No:	圖號/Drawing No:	核對/APPD. Joe
REV	概述/REVISION	日期/DATE			LW-ZH150S-XX-S	1501Z-XX-ST-S	製圖/DR. Mandy
							版數/Sheet 1 of 1
							REV. A0

SPECIFICATIONS

Current rating : 1A AC,DC
 Voltage rating : 100V AC,DC
 Temperature range : -25°C to +85 °C
 Contact resistance : 20mΩ Max.
 Insulation resistance : 500MΩ Min.
 Withstanding voltage : 500V AC/minute
 Material : Pin-Brass/Tin-plated
 Base-Nylon 9T, UL94V-0

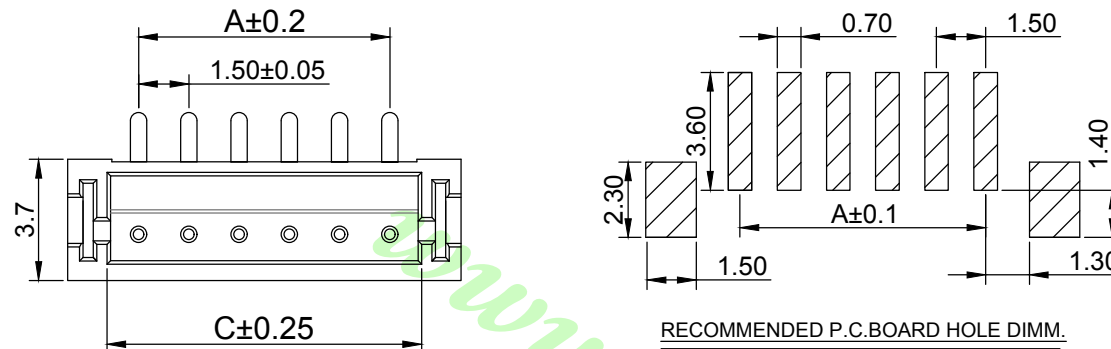

PART NO.:
LW-ZH 150 S - XX - SR

S: SMT Type
 R: Tape&Reel

No. Of Contact: 02~13

Angle Type: Straight Angle (180°)

Pitch: 1.50mm

Wafer Series No.

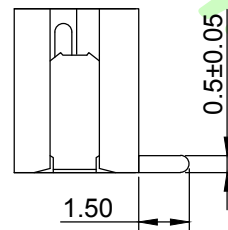
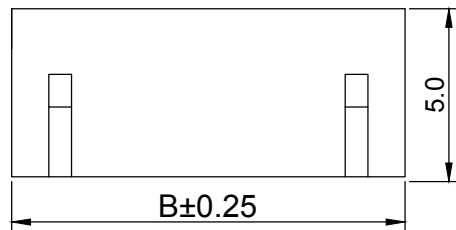

Ordering Information & Dimensions

Poles	Dimension (mm)			Part No.
	A	B	C	
2	1.50	6.00	3.60	LW-ZH150S-02-SR
3	3.00	7.50	5.10	LW-ZH150S-03-SR
4	4.50	9.00	6.60	LW-ZH150S-04-SR
5	6.00	10.50	8.10	LW-ZH150S-05-SR
6	7.50	12.00	9.60	LW-ZH150S-06-SR
7	9.00	13.50	11.10	LW-ZH150S-07-SR
8	10.50	15.00	12.60	LW-ZH150S-08-SR
9	12.00	16.50	14.10	LW-ZH150S-09-SR
10	13.50	18.00	15.60	LW-ZH150S-10-SR
11	15.00	19.50	17.10	LW-ZH150S-11-SR
12	16.50	21.00	18.60	LW-ZH150S-12-SR
13	18.00	22.50	20.10	LW-ZH150S-13-SR

		公差/UNLESS OTHERWISE SPECIFIED TOLERANCES ARE		單位/Unit mm	品名(Title) : 1.50mm Wire-to-Board Header SMT 180° TYPE Tape&Reel		LAI HENG TECHNOLOGY LTD. TEL: (02) 8228-6487 FAX: (02) 8228-6486
		X.XX ±0.2 X.X ±0.3		比例/Scale Free	料號/Part No : LW-ZH150S-XX-SR		
A0	NEW DRAWING	2018.08.16		Size A4	圖號/Drawing No : 1501Z-XX-ST-S-R		核對/APPD. Joe
REV	概述/REVISION	日期/DATE					製圖/DR. Mandy
							報數/Sheet 1 of 1
							REV. A0

2-9P Contacts

10-13P Contacts

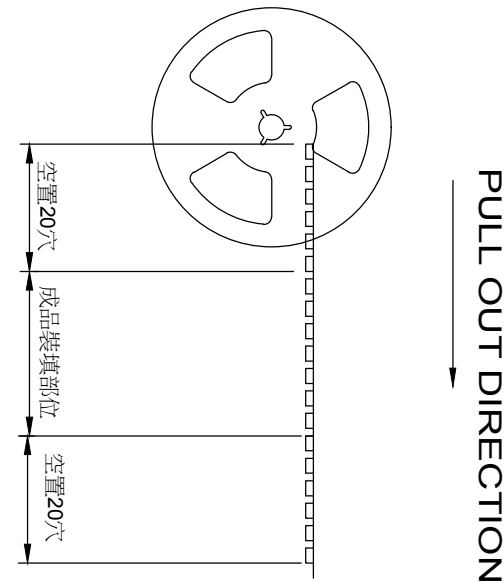
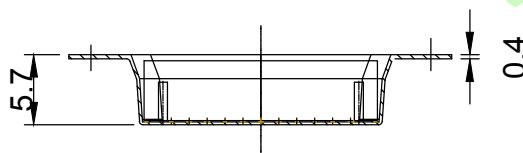
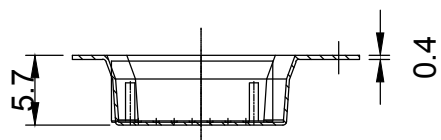
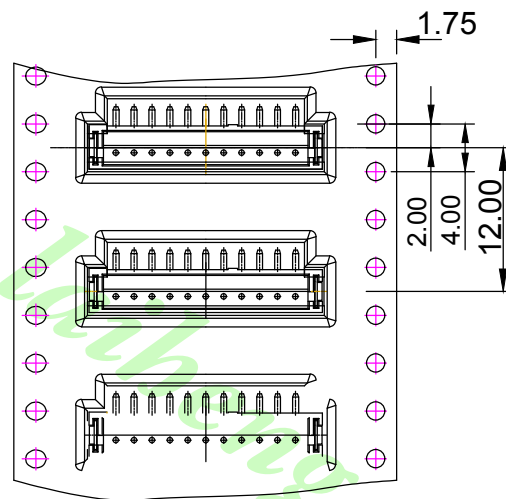
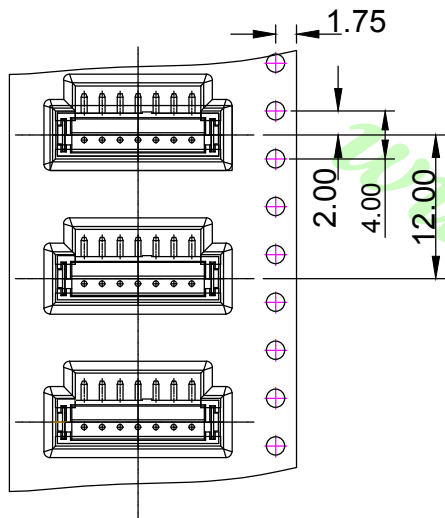

P=Poles	W	F	S	Q'TY/Reel
02	16	7.50	/	1000PCS
03	16	7.50		1000PCS
04	16	7.50		1000PCS
05	24	11.5		1000PCS
06	24	11.5		1000PCS
07	24	11.5		1000PCS
08	24	11.5		1000PCS
09	24	11.5		1000PCS
10	32	14.2		28.4
11	44	20.2	40.4	1000PCS
12	44	20.2	40.4	1000PCS
13	44	20.2	40.4	1000PCS

		公差/UNLESS OTHERWISE SPECIFIED TOLERANCES ARE		單位/Unit	品名(Title):		鍊亨電子有限公司 LAI HENG TECHNOLOGY LTD. TEL: (02) 8228-6487 FAX: (02) 8228-6486
		X.XX ±0.2 X.X ±0.3		mm	1.50mm Wire-to-Board Header SMT 180° TYPE Tape&Reel		
A0	NEW DRAWING	2018.08.16		比例/Scale	料號/Part No:	圖號/Drawing No:	核對/APPD. 740
REV	概述/REVISION	日期/DATE		Free Size A4	LW-ZH150S-XX-SR	1501Z-XX-ST-S-R	審核/CHKD. Joe
							製圖/DR. Mandy
							報數/Sheet 1 of 1
							REV. A0