

CKTS	DIM A	DIM B	DIM C	DIM D	DIM E	DIM F
4	1.50	2.60	6.50	7.60		
5	2.00	3.10	7.00	8.10		
6	2.50	3.60	7.50	8.60		
7	3.00	4.10	8.00	9.10		
8	3.50	4.60	8.50	9.60		
9	4.00	5.10	9.00	10.10		
10	4.50	5.60	9.50	10.60		
11	5.00	6.10	10.00	11.10		
12	5.50	6.60	10.50	11.60		
13	6.00	7.10	11.00	12.10		
14	6.50	7.60	11.50	12.60		
15	7.00	8.10	12.00	13.10		
16	7.50	8.60	12.50	13.60		
17	8.00	9.10	13.00	14.10		
18	8.50	9.60	13.50	14.60	4.40	5.65
19	9.00	10.10	14.00	15.10		
20	9.50	10.60	14.50	15.60		
21	10.00	11.10	15.00	16.10		
22	10.50	11.60	15.50	16.60		
23	11.00	12.10	16.00	17.10		
24	11.50	12.60	16.50	17.60		
25	12.00	13.10	17.00	18.10		
26	12.50	13.60	17.50	18.60		
27	13.00	14.10	18.00	19.10		
28	13.50	14.60	18.50	19.60		
29	14.00	15.10	19.00	20.10		
30	14.50	15.60	19.50	20.60		
31	15.00	16.10	20.00	21.10		
32	15.50	16.60	20.50	21.60		
33	16.00	17.10	21.00	22.10		
34	16.50	17.60	21.50	22.60		
35	17.00	18.10	22.00	23.10		
36	17.50	18.60	22.50	23.60		
37	18.00	19.10	23.00	24.10		
38	18.50	19.60	23.50	24.60		
39	19.00	20.10	24.00	25.10		
40	19.50	20.60	24.50	25.60		
41	20.00	21.10	25.00	26.10		
42	20.50	21.60	25.50	26.60		
43	21.00	22.10	26.00	27.10		
44	21.50	22.60	26.50	27.60		
45	22.00	23.10	27.00	28.10		
46	22.50	23.60	27.50	28.60		
47	23.00	24.10	28.00	29.10	4.95	6.20
48	23.50	24.60	28.50	29.60		
49	24.00	25.10	29.00	30.10		
50	24.50	25.60	29.50	30.60		
51	25.00	26.10	30.00	31.10		
52	25.50	26.60	30.50	31.60		
53	26.00	27.10	31.00	32.10		
54	26.50	27.60	31.50	32.60		
55	27.00	28.10	32.00	33.10		
56	27.50	28.60	32.50	33.60		
57	28.00	29.10	33.00	34.10		
58	28.50	29.60	33.50	34.60		
59	29.00	30.10	34.00	35.10		
60	29.50	30.60	34.50	35.60		

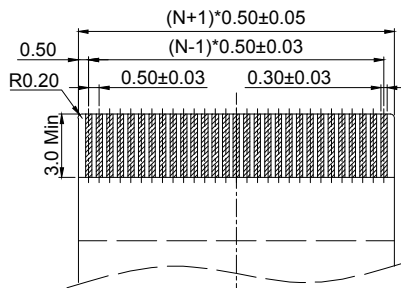
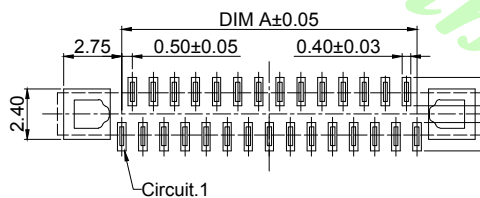
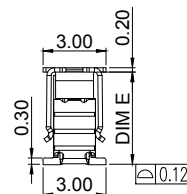
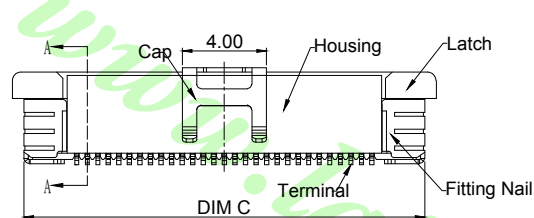
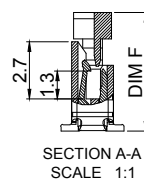
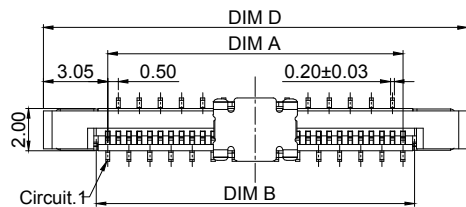

PART NO:

SERIES NO.	CONTACT TYPE	Pin no.	CONTACT PLATING	PACKAGE
LFPC-K841	N	XX	PT	X
FPC 0.5 Pitch ZIF SMT Vertical conn.	N: Normal Contact	04~60 pin	PT: Pure Tin G1: Gold Flash	1:Tube 2:Tape&Reel 5:Tape&Reel+Cap

Note:

1. Material:

Housing: Thermoplastic High Temp(LCP). UL94V-0; Color: Natural.
 Latch: Thermoplastic High Temp(LCP). UL94V-0; Color: Black.
 Terminal: Phosphor Bronze.
 Fitting Nail: Brass.
 Cap: Stainless Steel.

2. Finish:

Terminal: Matte Tin/Gold Flash over all.
 Fitting Nail: Matte Tin over all.

3. Electrical Characteristics:

Current Rating: 0.5A AC/DC.
 Voltage Rating: 50V AC/DC.
 Temperature Range: -25°C ~ +85°C.
 Withstand Voltage: 200V AC/Minute.
 Contact Resistance: 20mΩ max.
 Insulation Resistance: 500MΩ min.
 Relative Humidity: 93%+40°C.

公差/UNLESS OTHERWISE SPECIFIED TOLERANCES ARE

.X	±0.35
.XX	±0.15
.XXX	±0.05

單位/Unit
mm
比例/Scale
Free
Size
A4

品名(Title):

FPC 0.5mm ZIF Vertical SMD Normal type Conn

料號/Part No:

LFPC-K841-N-XX-XX-X

圖號/Drawing No:



鍊亨電子有限公司
LAI HENG TECHNOLOGY LTD.

TEL: (02) 8228-6487 FAX: (02) 8228-6486

核准/APPD: 7/6	審核/CHKD: Joe	製圖/DR: Mandy	張數/Sheet: 1 of 2	REV. A0
-----------------	-----------------	-----------------	---------------------	---------

PIN	B0±0.10	K0±0.10	W	W1	F	S0±0.10
4	6.80	4.70	16+0.3/-0	16.4	7.5±0.10	單邊孔
5	7.30					
6	7.80					
7	8.30					
8	8.80					
9	9.30					
10	9.80					
11	10.30					
12	10.80					
13	11.30					
14	11.80					
15	12.30					
16	12.80					
17	13.30					
18	13.80					
19	14.30					
20	14.80					
21	15.30					
22	15.80					
23	16.30					
24	16.80					
25	17.30					
26	17.80					
27	18.30					
28	18.80					
29	19.30					
30	19.80					
31	20.30					
32	20.80					
33	21.30					
34	21.80					
35	22.30					
36	22.80					
37	23.30					
38	23.80					
39	24.30					
40	24.80					
41	25.30					
42	25.80					
43	26.30					
44	26.80					
45	27.30					
46	27.80					
47	28.30					
48	28.80					
49	29.30					
50	29.80					
51	30.30					
52	30.80					
53	31.30					
54	31.80					
55	32.30					
56	32.80					
57	33.30					
58	33.80					
59	34.30					
60	34.80					
		5.25	44±0.30	44.4	20.2±0.15	40.4
			56±0.30	56.4	26.2±0.15	52.4

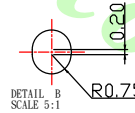
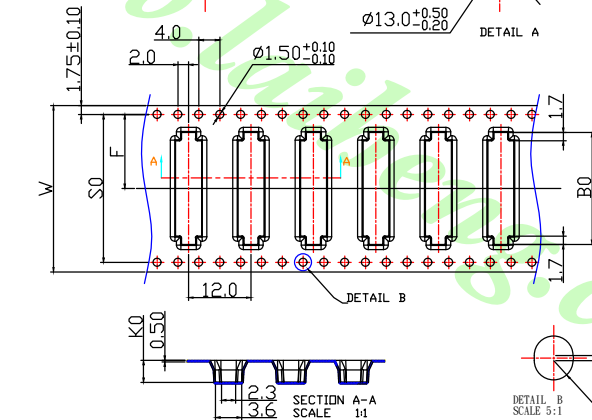
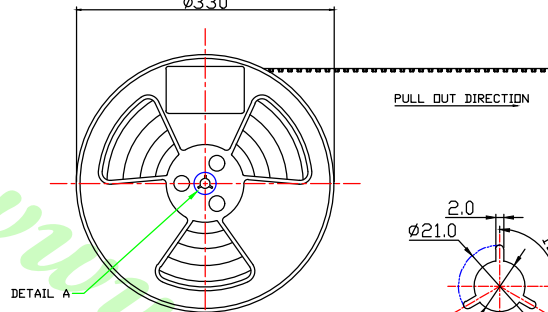
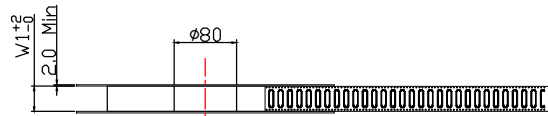

NOTES:

1. 10 SPROCKET HOLE PITCH CUMULATIVE TOLERANCE: ±0.20mm
2. CARRIER CAMBER NOT TO EXCEED 1mm IN 250mm.
3. ALL DIMENSIONS MEET EIA-481-C REQUIREMENTS.
4. MATERIAL: BLACK ANTI-STATIC POLYSTYRENE.
5. THICKNESS: 0.50 ± 0.05 mm.
6. PACKING LENGTH PER 13" REEL : 12.60METERS.
7. COMPONENT LOAD PER 13" REEL : 1000PCS.
8. PEELING OFF FORCE OF TOP TAPE 0.1N~0.7N(10.2gf~100gf).

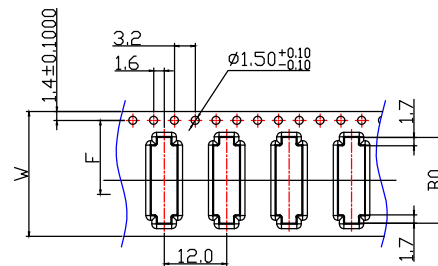
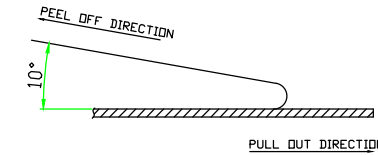
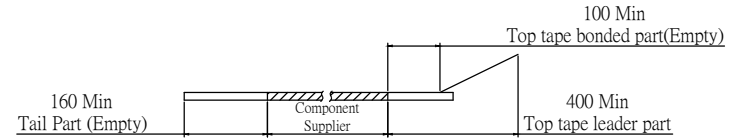

PART NO:

SERIES NO.	CONTACT TYPE	Pin no.	CONTACT PLATING	PACKAGE
LFPC-K841	N	XX	PT	X
FPC 0.5 Pitch ZIF SMT Vertical conn.	N: Normal Contact	04~60 pin	PT : Pure Tin G1 : Gold Flash	2:Tape&Reel 5:Tape&Reel+Cap

REV	概述/REVISION	日期/DATE	公差/UNLESS OTHERWISE SPECIFIED TOLERANCES ARE	單位/Unit mm	品名(Title):
A0	NEW DRAWING	2018.06.13	.X ±0.35 .XX ±0.15 .XXX ±0.05	Free	FPC 0.5mm ZIF Vertical SMD Normal type Conn
				比例/Scale	料號/Part No : LFPC-K841-N-XX-XX-X
				Size	圖號/Drawing No :
				A4	



鍊亨電子有限公司
LAI HENG TECHNOLOGY LTD.
TEL:(02) 8228-6487 FAX:(02) 8228-6486

核准/APPD: 7/0	審核/CHKD: Joe	製圖/DR: Mandy	張數/Sheet: 2 of 2	REV: A0
--------------	--------------	--------------	------------------	---------